

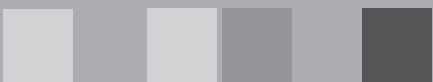

Product Catalogue

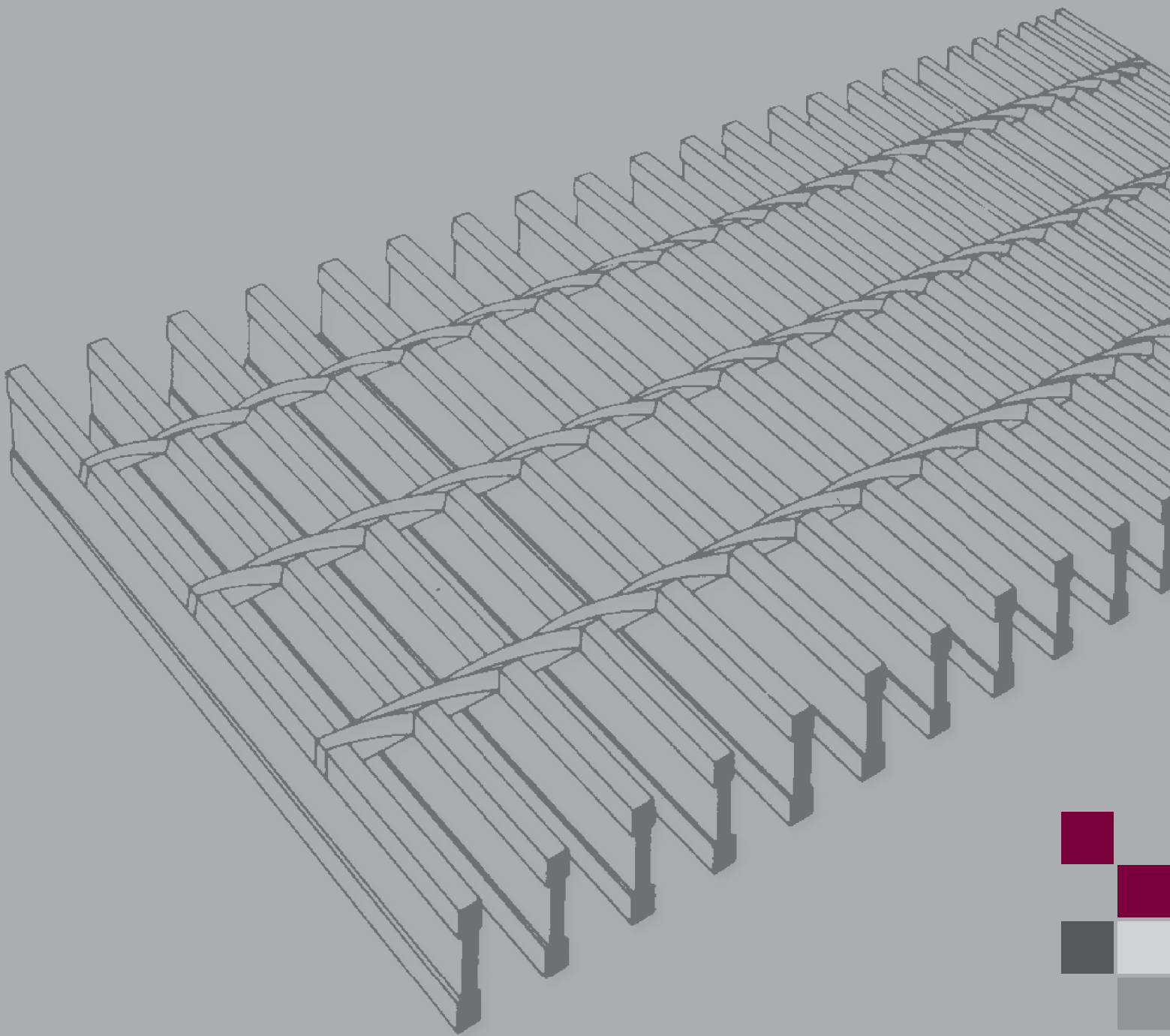

A Unique Product

Product range designed for the Australasian market

Our manufacturing factory boasts an extensive product range with a simplified key range of options packaged specifically for the New Zealand and Australian market.

Perry Grating product groups:

- Load bar centres: 30mm load bar centres for high foot traffic. 40mm load bar centres for low foot traffic.

Important please note: we can supply 60mm centres but this size does not meet AS/NZ standards for elevated platforms.

Long-term cost savings

Multi-purpose and diversity are some of the best attributes a product can offer, and the Perry Grating products certainly offer these. Grating has many uses – not only in industry as walkway flooring but also as screens, drain covers and stairways.

Better still, Perry Grating is unique!

Similar to a steel 'I Beam' where the strength is in the flanges, the bar profile gives a 25% weight reduction while retaining strength.

This design saves not only weight, but also material cost and galvanizing cost. Savings are also made in the design of the supporting structure for the grate, as the product is so much lighter and stress is reduced.

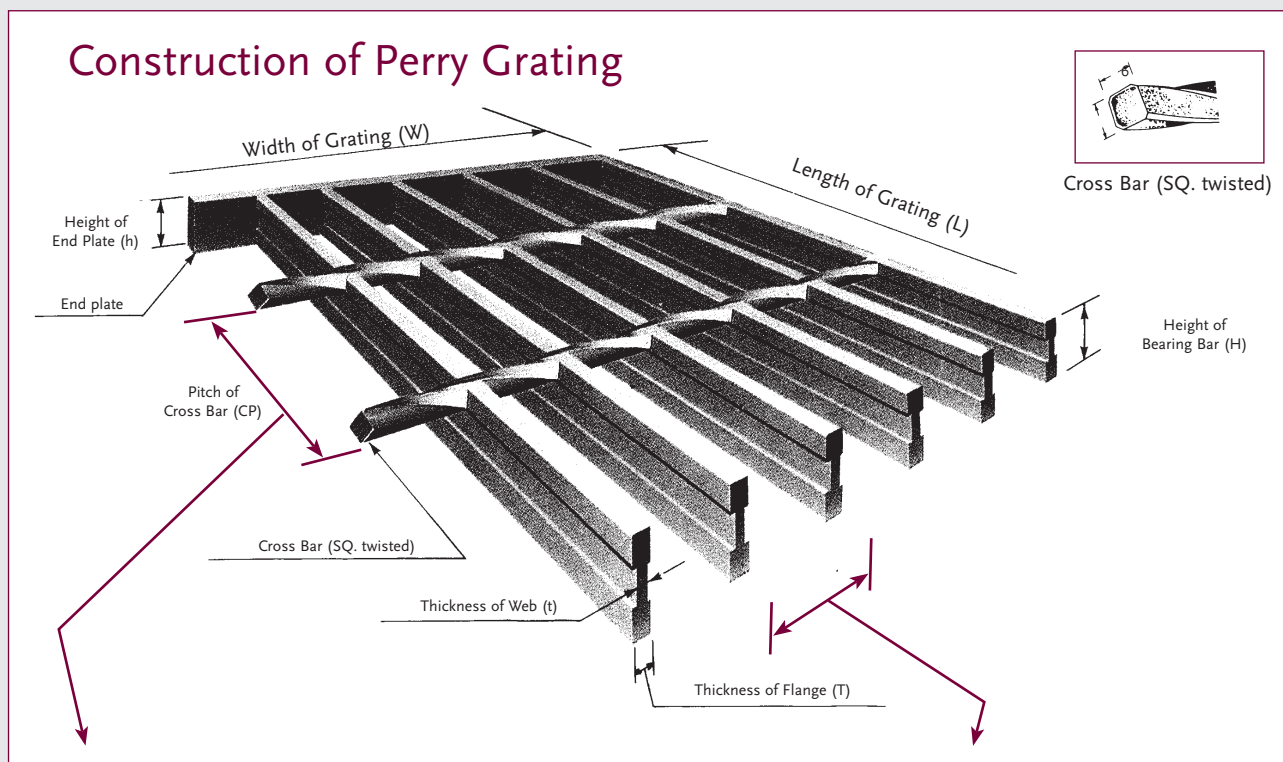

Pitch of Cross Bar

A centre distance between the two cross bars adjacent to each other is called pitch of cross bar, and its standard is 100mm.

Pitch of Bearing Bar

A centre distance between the two bearing bars adjacent to each other is called pitch of load bar. Standard pitch is 30mm (Series 1), 40mm (Series 2).

How to order Perry Grating

Stock panels ready to use off the shelf

We carry a full range of off the shelf stock panel sizes. All panels are Series One 995 x 5800mm and Series Two 1005 x 5800mm, and sizes range from 20mm load bar to 75mm load bar. Please contact us for sizes and availability of the quantity you require. Phone 0800 425 848

Panels are fabricated normally to the nearest load bar spacing e.g 600mm - 605mm.

We recommend 4 fixing clips per square metre.

Made to order

What we require from the client:

- Type of load bar required
- Load bar centres (ie. 30mm, 40mm)
- Load bar directions
- Cutouts fully dimensioned
- Kick plate detail if any



Auckland Container Port

International Standards Guaranteed

When quality is the cornerstone of all operations, standards must follow international benchmarks.

Supplied throughout Australasia PERRY GRATING is made to international standards and the factory is accredited to **ISO 9001:2000**.

The ISO 9001:2000 is an international quality management system involving external audits and stringent quality management criteria.

Incorporating fourteen grate forging machines, the factory has high manufacturing tolerances.

This is shown in the unique vertical alignment of the load bars resulting in a stronger, better-looking product for our customers.

The standard applicable for galvanizing is **AS/NZS 4680 – Hot Dip Galvanized (zinc) coatings on fabricated ferrous articles**.

As drawn

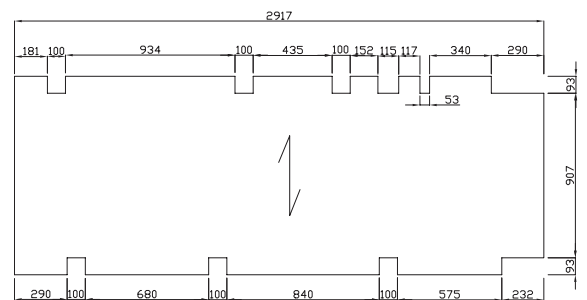

As detailed

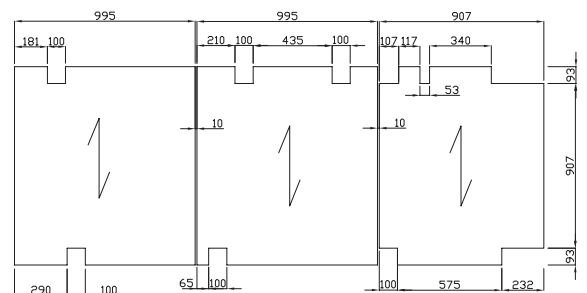

Standard Stanchions

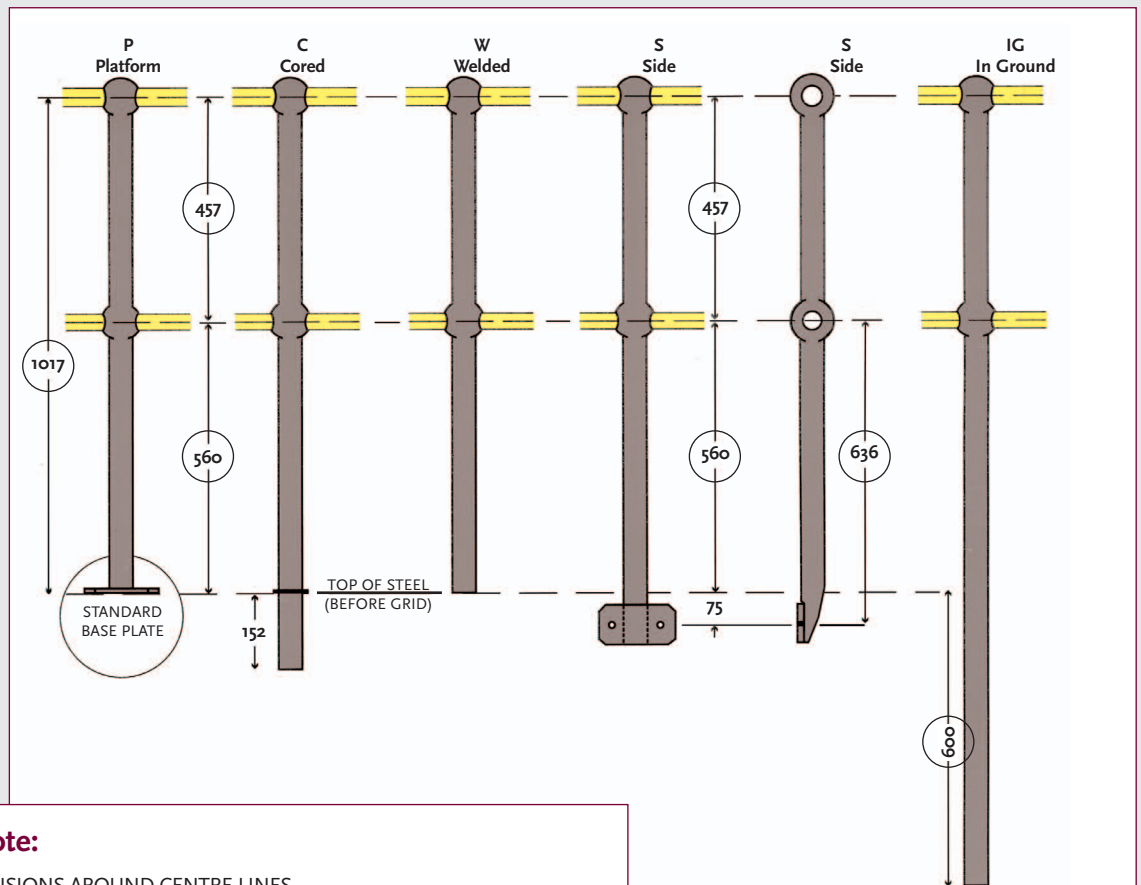

Please note:

- ALL DIMENSIONS AROUND CENTRE LINES
- ALL DIMENSIONS IN mm
- ALL DIMENSIONS SHOWN CAN BE ALTERED TO SUIT ANY REQUIREMENTS
- ALL STANCHIONS AVAILABLE DRILLED ONE SIDE ONLY (D.O.S.O.)

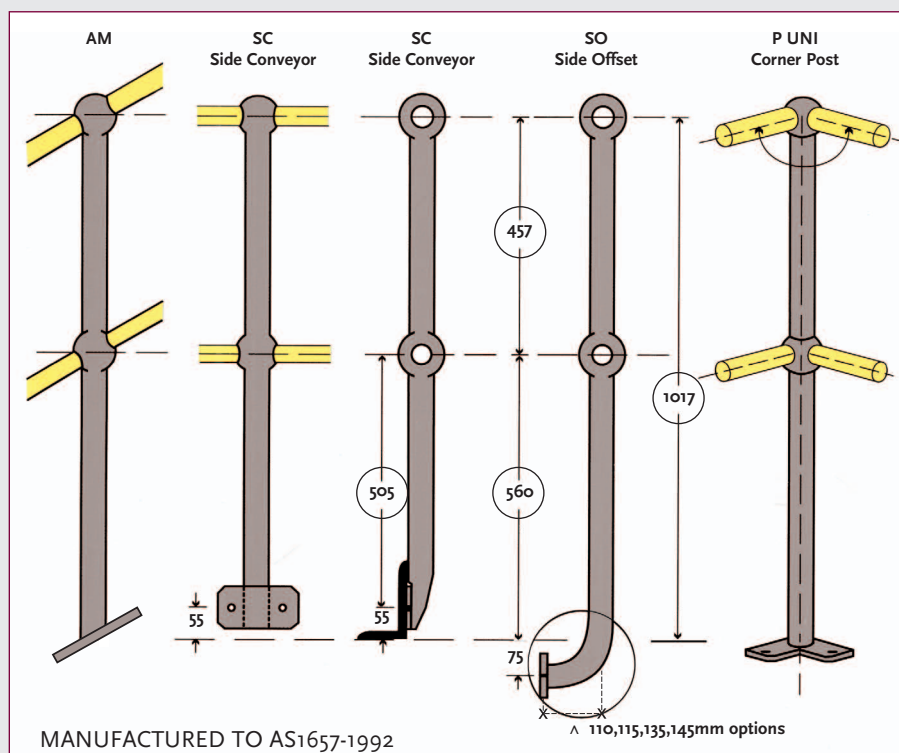

Sydney Tower

* BEFORE ORDERING:
Check suitability of this dimension to match adjoining horizontal rail and adjust if necessary.

A Walkway System

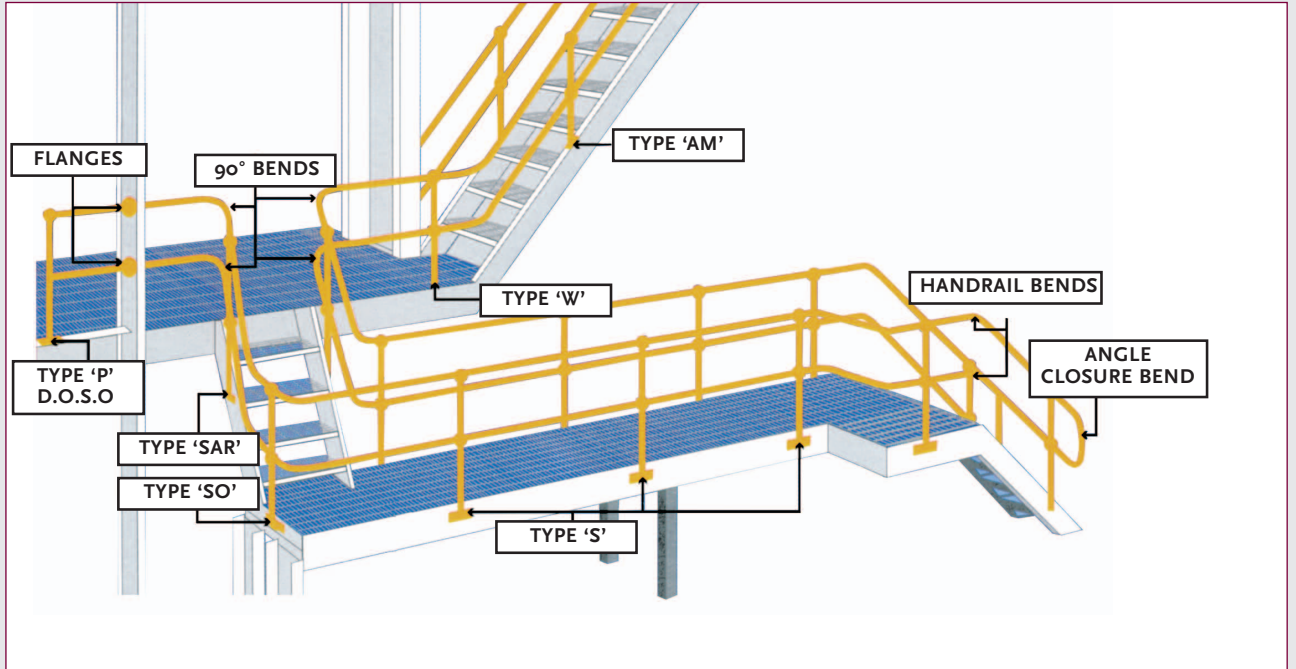

Pohokura Oil Project

Hand Rail and Grating Accessories

Closure and Rail Bends

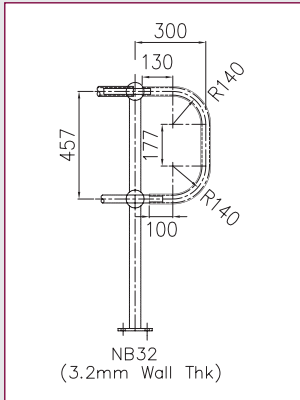

End Closure Bends

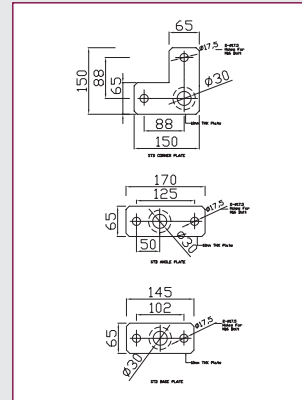

Corner Base Plates

AM Base Plates

Standard Base Plates

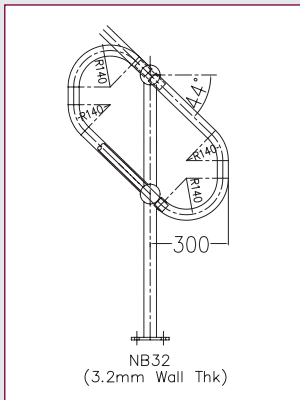

Angle Closure Bends to suit AM Stanchions

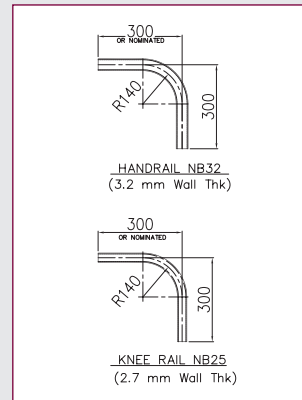

Top Rail Bends

Knee Rail Bends

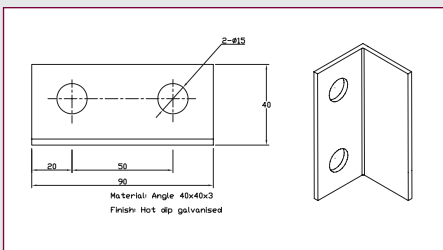

Kickplate Bracket

Important note:

A minimum of four clips per panel must be used to restrain floor panels. Where larger panels are to be fixed, it is advisable to use extra clips on any available intermediate supports.

1. Field welding

Recommended for all permanently installed gratings, and for gratings that are to be removed only at infrequent intervals.

This can be secured quickly and safely by one person, working from the floor surface.

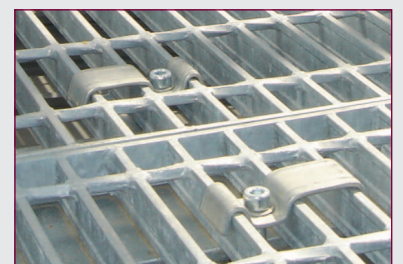
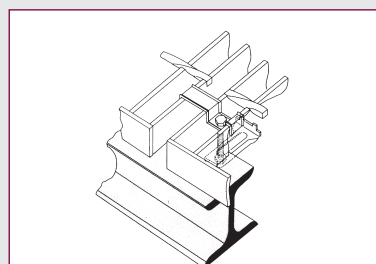
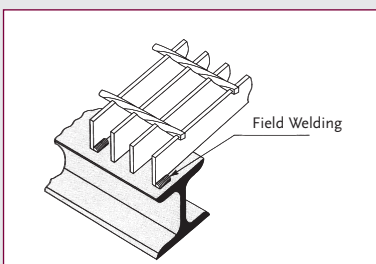
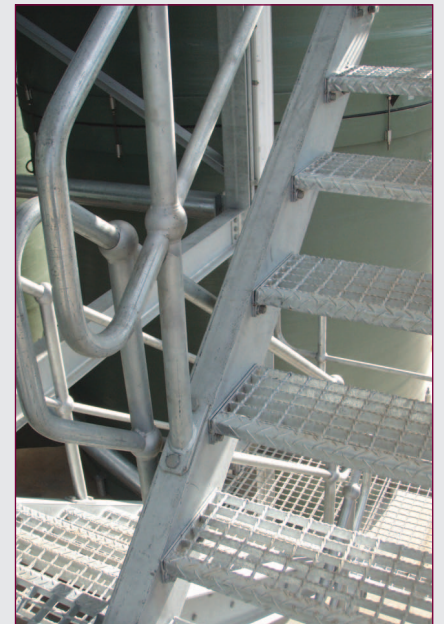

Stair Treads

Made to order

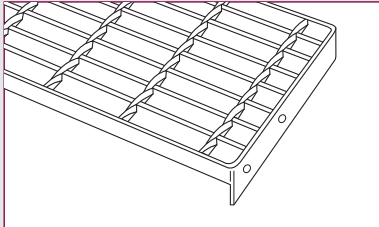

PT1
Welded
Banded only

PT2
Bolted
end plates

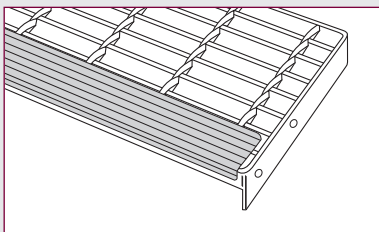

PT3
Welded
Banded only
with strip
nosing

PT4
Bolted
plates with
with strip
nosing

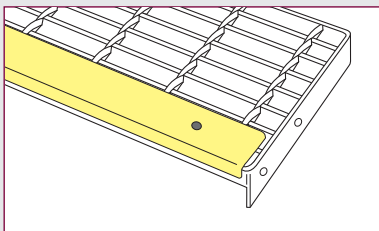

PT5
Welded
Banded only
abrasive
nosing

PT6
Bolted
end plates
abrasive
nosing



* Stair Treads also available in FRP.

Made to order

We can supply any size/configuration of stair tread at competitive rates and delivery times.

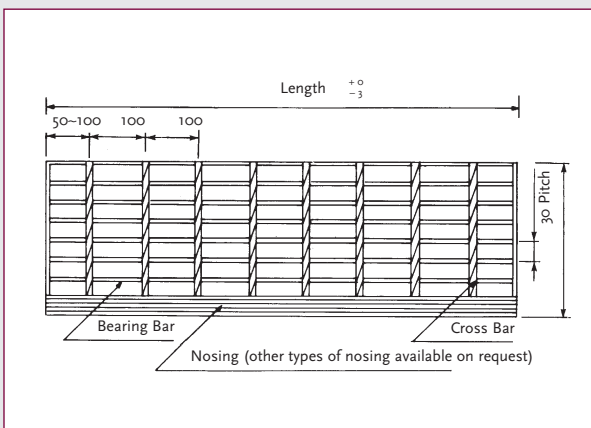
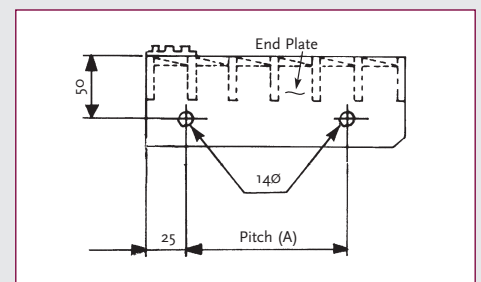

Recommended Tread Width

Load bearing bars at 30mm or 40mm pitch

Width (mm)	215	245	275	305
Bolt pitch (A)	125	125	125	125
Length (mm)	as requested			
Size of bearing bars (H)				

MILD STEEL GRATING



LOAD AND DEFLECTION TABLE - SERIES I (LOAD BAR PITCH 30MM)

Grating Code	Load Bar Size (mm)	Serrated Bar Factors		Weight per m ² (kg)	Span (mm)																
		S	D		600	750	900	1050	1200	1350	1500	1650	1800	1950	2100	2250	2400	2550	2700	2850	3000
					S	D	S	D	S	D	S	D	S	D	S	D	S	D	S	D	S
PG203/FB	19X3			19	3.73	4.66	5.59	6.85	8.95												
					0.7	1.38	2.38	3.97	6.77												
PG205/FB	20x5			29.5	1.36	2.13	3.06	4.17	5.44	6.89											
					0.24	0.58	1.21	2.23	3.81	6.11											
PG253/FB	25x3	0.88	1.21	24	2.16	2.70	3.23	3.96	5.18	6.55	8.09										
					0.31	0.60	1.04	1.73	2.96	4.74	7.23										
PG255/IB	25x5	0.82	1.30	32	1.39	1.74	2.09	2.56	3.35	4.24	4.71	6.33									
					0.12	0.29	0.61	1.12	1.91	3.06	4.67	6.84									
PG255/FB	25 x 5	0.88	1.20	36.2	0.89	1.39	2.00	2.72	3.56	4.50	5.56	6.72	8.00								
					0.12	0.30	0.63	1.17	1.99	3.19	4.86	7.12	10.08								
PG303/FB	32x3	0.91	1.16	30	1.32	1.65	1.98	2.42	3.16	4.00	4.94	5.98	7.12								
					0.15	0.29	0.50	0.83	1.41	2.26	3.45	5.05	7.15								
PG305/IB	32x5	0.84	1.25	38	0.86	1.08	1.29	1.59	2.07	2.62	3.24	3.92	4.66	5.47	6.34						
					0.10	0.19	0.33	0.54	0.93	1.48	2.26	3.31	4.68	6.45	8.68						
PG305/FB	30 x 5	0.91	1.15	45.5	0.56	0.87	1.25	1.71	2.23	2.82	3.48	4.22	5.02	5.89	6.83						
					0.06	0.15	0.31	0.57	0.98	1.56	2.38	3.49	4.94	6.81	9.15						
PG405/IB	40x5	0.89	1.16	50	0.46	0.58	0.69	0.85	1.11	1.40	1.73	2.09	2.49	2.92	3.39	3.89	4.43	5.00	5.60	6.24	
					0.04	0.07	0.13	0.21	0.36	0.58	0.88	1.28	1.82	2.51	3.37	4.44	5.75	7.32	9.20	11.43	
PG505/IB	50x5	0.92	1.12	55	0.37	0.46	0.55	0.67	0.88	1.11	1.37	1.66	1.98	2.32	2.69	3.09	3.51	3.97	4.45	4.96	5.49
					0.03	0.05	0.09	0.15	0.25	0.40	0.61	0.90	1.27	1.75	2.00	3.10	4.02	5.12	6.43	7.99	9.81
PG657/FB	65x7			85	0.18	0.23	0.28	0.34	0.44	0.56	0.69	0.84	1.00	1.17	1.36	1.56	1.78	2.00	2.25	2.50	2.77
					0.01	0.02	0.034	0.057	0.098	0.156	0.24	0.35	0.49	0.68	0.91	1.21	1.56	1.99	2.50	3.10	3.81
PG757/FB	75x7			96	0.14	0.17	0.21	0.26	0.33	0.42	0.52	0.63	0.75	0.88	1.03	1.17	1.37	1.51	1.69	1.88	2.09
					0.007	0.013	0.022	0.037	0.064	0.102	0.155	0.228	0.322	0.444	0.597	0.787	1.019	1.30	1.63	2.03	2.49

• The shaded area of the table indicates grating with deflection less than span/300mm

• If serrated bar grating is selected, use the factors S and D to calculate stress and deflection

• For uniformly distributed loads other than 300kg/m² (3kPa) grating stress and deflection can be calculated using the factor shown in the following table

S = Stress in kg/mm²

D = Deflection in mm

Allowable Stress: 18kg/mm² (180MPa)

Allowable Deflection: L(Span)/300mm

Sample Calculation

Uniform Load: 500kg/m² (5kPa) → factor (i) Of

1.67 Grating code: PG.305/1 Span: 1500mm

Stress (S) = 3.24 x 1.67 = 5.41kg/mm²

Deflection (D) = 2.26 x 1.67 = 3.77mm

STRESS AND DEFLECTION FACTOR

Uniform Load kg/m ²	200	250	300	400	500	750
Factor (i)	0.67	0.83	1	1.33	1.67	2.5

MILD STEEL GRATING



LOAD AND DEFLECTION TABLE - SERIES II (LOAD BAR PITCH 40MM)

Grating Code	Load Bar Size (mm)	Serrated Bar Factors		Weight per m ² (kg)	Span (mm)																					
		S	D		600	750	900	1050	1200	1350	1500	1650	1800	1950	2100	2250	2400	2550	2700	2850	3000					
					S	D	S	D	S	D	S	D	S	D	S	D	S	D	S	D	S	D	S	D		
PG205-FB	20 x 5			22.5	S 1.78	D 0.31	S 2.88	D 0.41	S 1.86	D 0.266	S 1.15	D 0.16	S 1.76	D 0.20	S 1.15	D 0.128	S 0.72	D 0.08	S 0.61	D 0.05	S 0.49	D 0.035	S 0.21	D 0.012	S 0.16	D 0.008
PG253-FB	25x3	0.88	1.21	20	S 2.88	D 0.41	S 3.59	D 0.80	S 2.32	D 0.519	S 1.80	D 0.16	S 2.20	D 0.38	S 1.44	D 0.25	S 1.12	D 0.19	S 0.77	D 0.09	S 0.61	D 0.035	S 0.26	D 0.023	S 0.20	D 0.016
PG255-IB	25x5	0.82	1.30	26	S 2.79	D 0.39	S 4.31	D 0.80	S 2.79	D 0.519	S 2.60	D 0.39	S 3.42	D 0.66	S 2.11	D 0.25	S 1.62	D 0.22	S 1.13	D 0.09	S 0.90	D 0.068	S 0.39	D 0.039	S 0.29	D 0.025
PG255-FB	25 x 5	0.88	1.2	27.4	S 2.79	D 0.39	S 4.31	D 0.80	S 2.79	D 0.519	S 2.60	D 0.39	S 3.42	D 0.66	S 2.11	D 0.25	S 1.62	D 0.22	S 1.13	D 0.09	S 0.90	D 0.068	S 0.39	D 0.039	S 0.29	D 0.025
PG303-FB	32x3	0.91	1.30	24	S 2.64	D 0.38	S 3.23	D 0.66	S 2.64	D 0.42	S 2.64	D 0.38	S 3.23	D 0.66	S 2.11	D 0.25	S 1.62	D 0.22	S 1.13	D 0.09	S 0.90	D 0.068	S 0.39	D 0.039	S 0.29	D 0.025
PG305-IB	32x5	0.84	1.16	30	S 2.76	D 0.35	S 3.50	D 0.62	S 2.76	D 0.46	S 2.76	D 0.35	S 3.50	D 0.62	S 2.76	D 0.46	S 2.11	D 0.25	S 1.48	D 0.16	S 1.13	D 0.09	S 0.64	D 0.039	S 0.50	D 0.025
PG305-FB	30 x 5	0.91	1.15	34.2	S 2.88	D 0.38	S 3.64	D 0.62	S 2.88	D 0.46	S 2.88	D 0.38	S 3.64	D 0.62	S 2.11	D 0.25	S 1.62	D 0.22	S 1.13	D 0.09	S 0.90	D 0.068	S 0.39	D 0.039	S 0.29	D 0.025
PG405-IB	40x5	0.89	1.25	40	S 2.88	D 0.38	S 3.64	D 0.62	S 2.88	D 0.46	S 2.88	D 0.38	S 3.64	D 0.62	S 2.11	D 0.25	S 1.62	D 0.22	S 1.13	D 0.09	S 0.90	D 0.068	S 0.39	D 0.039	S 0.29	D 0.025
PG505-IB	50x5	0.92	1.16	45	S 2.88	D 0.38	S 3.64	D 0.62	S 2.88	D 0.46	S 2.88	D 0.38	S 3.64	D 0.62	S 2.11	D 0.25	S 1.62	D 0.22	S 1.13	D 0.09	S 0.90	D 0.068	S 0.39	D 0.039	S 0.29	D 0.025
PG657-FB	65x5		1.12	78	S 2.88	D 0.38	S 3.64	D 0.62	S 2.88	D 0.46	S 2.88	D 0.38	S 3.64	D 0.62	S 2.11	D 0.25	S 1.62	D 0.22	S 1.13	D 0.09	S 0.90	D 0.068	S 0.39	D 0.039	S 0.29	D 0.025
PG757-FB	75x7			87	S 2.88	D 0.38	S 3.64	D 0.62	S 2.88	D 0.46	S 2.88	D 0.38	S 3.64	D 0.62	S 2.11	D 0.25	S 1.62	D 0.22	S 1.13	D 0.09	S 0.90	D 0.068	S 0.39	D 0.039	S 0.29	D 0.025

- The shaded area of the table indicates grating with deflection less than span/300mm
- If serrated bar grating is selected, use the factors S and D to calculate stress and deflection
- For uniformly distributed loads other than 300kg/m² (3kPa) grating stress and deflection can be calculated using the factor shown in the following table

S = Stress in kg/mm²
 D = Deflection in mm
 Allowable Stress: 18kg/mm² (180MPa)
 Allowable Deflection: L(Span)/300mm

STRESS AND DEFLECTION FACTOR

Uniform Load kg/m ²	200	250	300	400	500	750
Factor (i)	0.67	0.83	1	1.33	1.67	2.5

Sample Calculation

Uniform Load: 500kg/m² (5kPa) → factor (i) Of 1.67
 Grating code: PG305/2 Span: 1500mm
 Stress (S) = 4.32 x 1.67 = 7.41kg/mm²
 Deflection (D) = 3.01 x 1.67 = 5.03mm

Loading Tables

Light and medium duty (maximum recommended spans)

Load bar size	Maintenance floors No public use		Pedestrian traffic Public, residential and light use		Pedestrian traffic Public, commercial and crowd use	
	2.5Kpa Deflection = 5mm		3.0Kpa Deflection = 5mm		4.0Kpa Deflection = 5mm	
	Series 1	Series 2	Series 1	Series 2	Series 1	Series 2
PG 253	1410	1310	1350	1250	1250	1170
PG 303	1700	1580	1620	1510	1510	1400
PG 255	1590	1480	1520	1420	1420	1320
PG 305	1910	1780	1820	1700	1700	1580
PG 405	2420	2250	2310	2150	2150	2000
PG 505	Not applicable		Not applicable		Not applicable	
PG 657	Not applicable		Not applicable		Not applicable	
PG 757	Not applicable		Not applicable		Not applicable	

Heavy duty (maximum recommended spans)

Load bar size	General factories and workshops, motor rooms, wheel trolleys				General heavy loading areas, boiler equipment, heavy equipment areas			
	5.0Kpa				7.5Kpa			
	Deflection = 5mm		Deflection = 10mm		Deflection = 5mm		Deflection = 10mm	
	Series 1	Series 2	Series 1	Series 2	Series 1	Series 2	Series 1	Series 2
PG 253	Not applicable				Not applicable			
PG 303	Not applicable				Not applicable			
PG 255	1340	1250	1590	1480	1210	1130	1440	1340
PG 305	1610	1500	1910	1780	1450	1350	1730	1610
PG 405	2040	1890	2420	2250	1840	1710	2190	2040
PG 505	2220	2070	2650	2460	2010	1870	2390	2230
PG 657	2940	2730	3500	3250	2650	2470	3160	2940
PG 757	3260	3040	3890	3620	2950	2750	3510	3270



Pohokura Oil Project

FRP

Moulded FRP Grating

Fibre Reinforced Plastic (FRP) gratings are widely used as trench covers, grills, floorings, platforms, ramps, pet covers, tower packing supports, walkways, stairs, battery racks, screens, bridges, railings, machinery guards, wash racks, etc. in the industries such as chemical, petroleum, electronics, paper, printing and dyeing, water treatment, pollution control, offshore, power, brewing.

- Sheet sizes are 1220 x 3660
- Cut to order or standard stock panels
- 25mm depth
- 38mm depth
- 50mm depth
- Available in both isophalic or vinylester resin
- Anti slip grit top standard



Load Sheet Under 1% Deflection

Description	Span (mm)	Concentrated Point Load (kg)	Concentrated Line Load (kg/300mm)	Uniform Load (kg/sqm)
Mesh size (mm): 38.1 x 38.1 Thick: 25.4 mm	305	1050	683	4956
	457	582	297	2943
	610	338	158	1224
	914	187	71	397
Mesh size (mm): 38.1 x 38.1 Thick: 38.1 mm	1219	142	-	160
	305	1909	1457	14270
	457	1611	998	8163
	610	1211	552	4140
Mesh size (mm): 40 x 40 Thick: 40 mm	914	688	245	1421
	1219	526	137	563
	305	1909	1567	15210
	457	1622	1032	8441
Mesh size (mm): 40 x 40 Thick: 40 mm	610	1421	637	4889
	914	710	275	1452
	1000	674	232	1133
	Mesh size (mm): 50.7 x 50.7 Thick: 50.8 mm	305	-	2183
457		6669	1552	15964
610		2580	896	7461
914		1313	417	2545
Mesh size (mm): 25 x 100 Thick: 25 mm	1219	959	238	1105
	305	1242	1015	11637
	457	715	479	4656
	610	420	248	2035
Mesh size (mm): 25 x 100 Thick: 25 mm	914	250	105	572
	1000	228	90	447

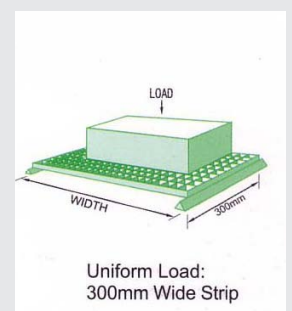
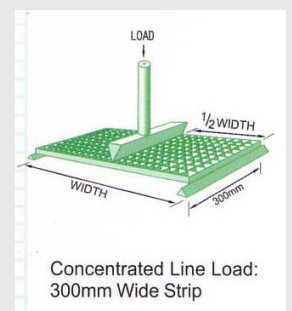
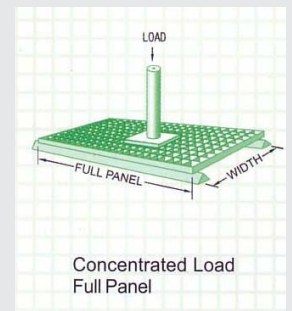

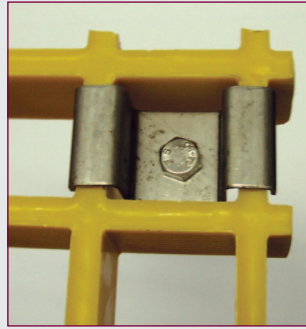
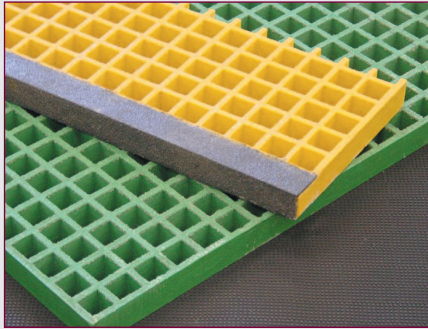

Chemical Resistance Guide for FRP Grating

CHEMICAL ENVIRONMENT	VINYL ESTER RESIN		ISOHPHTHALIC POYESTER RESIN	
	Concentration (%)	Max. Oper. Temp. (C)	Concentration (%)	Max. Oper. Temp. (C)
Hydrochloric Acid	37	65	37	24
Sulfuric Acid	50	80	25	24
Nitric Acid	20	54	20	21
Phosphoric Acid	100	99	100	49
Hydrobromic Acid	50	65	50	49
Tartaric Acid	ALL	99	ALL	77
Lactic Acid	ALL	99	ALL	77
Oxalic Acid	ALL	99	ALL	24
Borax	SAT	99	SAT	77
Citrix Acid	ALL	99	ALL	77
Acetic Acid	50	82	50	52
Benzoic Acid	SAT	99	SAT	66
Methacrylic Acid	99	35	-	-
Hydrofluoric Acid	10	65	-	-
Ferric Chloride	ALL	99	ALL	77
Sodium Sulfate	ALL	99	ALL	77
Ammonium Chloride	ALL	99	ALL	77
Magnesium Sulfate	ALL	99	ALL	77
Potassium Nitrate	ALL	99	ALL	77
Sodium Cyanide	ALL	99	ALL	77
Sodium Hydroxide	10	68	N/R	-
Calcium Carbonate	ALL	82	ALL	77
Carbon Tetrachloride	THICK	40	N/R	-
Formaldehyde	37	60	50	24
Methanol	10	84	N/R	-
Ethanol	10	82	50	24
Gasoline	100	82	100	24
Benzene	THICK	40	N/R	-
Glycerine	100	99	100	66
Water Distilled	100	82	100	77
Sea Water	ALL	99	ALL	70
Glucose	100	99	100	77
Vinegar	100	99	100	77
Chlorine Water	SAT	93	SAT	27

Manufacturing Tolerances

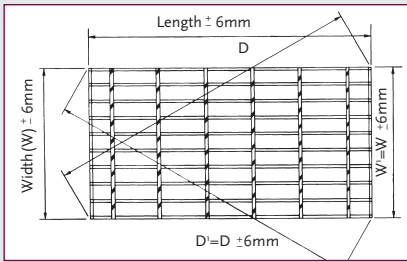

W and W' are overall lengths of cross bars at opposite ends of panel.

D and D' are overall diagonal dimensions

Transverse Bow

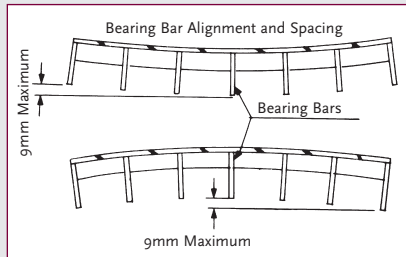

Longitudinal Bow

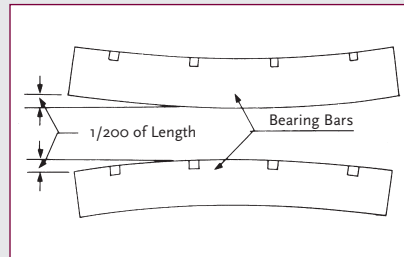

Cross Bar Location and Bearing Bar

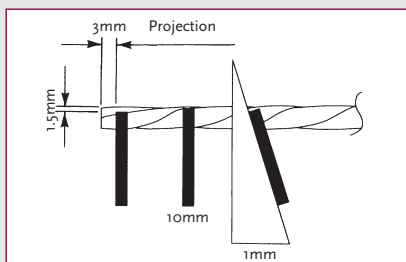

LOAD BAR CHART

Number of Bars	Series 1 & 2	FRP
41	1205	1530
40	1175	1492
39	1145	1454
38	1115	1416
37	1085	1378
36	1055	1339
35	1025	1301
34	995	1263
33	965	1225
32	935	1187
31	905	1149
30	875	1111
29	845	1073
28	815	1035
27	785	997
26	755	958
25	725	920
24	695	882
23	665	844
22	635	806
21	605	768
20	575	730
19	545	692
18	515	654
17	485	616
16	455	577
15	425	539
14	395	501
13	365	463
12	335	425
11	305	387
10	275	349
9	245	311
8	215	273
7	185	235
6	155	196
5	125	158
4	95	120
3	65	82
2	35	44





NOTE:

- Sizes are overall outside to outside of bars.
- Calculations based on 5mm bars for
- Series 1 & 2.6mm for FRP
- FRP bar centres are at 38.1mm

Grating Types

I Bar Type Grating

The bearing bar comes in the form of an I-Section. This type of grating is used where high strength is required and light weight is critical. Commonly used for platforms and walkways.

PG 255	PG 305	PG 405	PG 505
			

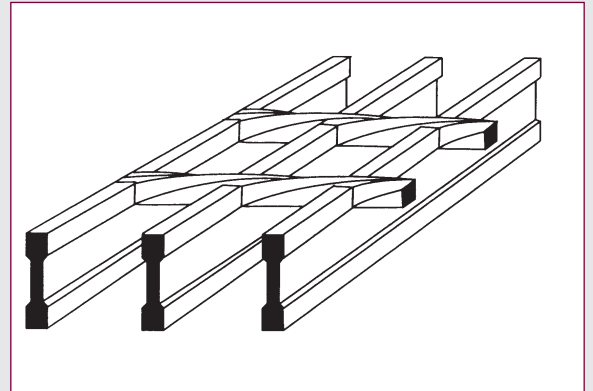

- P note:
- Load bar sizes range from 20mm to 100mm depth
 - Are available in both FLAT BAR and I BAR

Serrated Type I Bar Grating

The bearing bar comes in the form of an I-Section with the top surface formed by a series of notches. In addition to its high strength and light weight, this type of grating also has non-slip characteristics, no sharp edges and serrations are rolled on, to meet strict health and safety requirements. Hot rolled serrations help stop lacerations if someone falls on the grating.

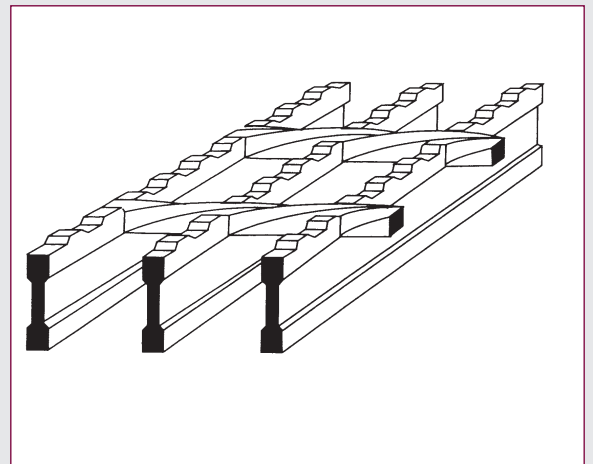

Pohokura Oil Project

Terminology for Grating

Load Bar

Flat bar or I bar from which grating is made

Cross bar

This is a twisted square bar forged into the top of the load bar.

In Stainless Steel Grating this is a round bar forged into the top of the load bar.

In Aluminium this is a square bar inserted through punched holes in the load bar and swaged to hold it in position.

Banded

This refers to the process of welding a flat bar to the load bars after they have been cut to size to provide a uniform appearance around all sides of a grating panel. This process also helps prevent injury from laceration during installation and assists in keeping the panels flat.

Cut to Size Only

Refers to the process of leaving the panels with a raw cut edge and not banded as described above.

Exact Size

Refers to the requirement to make the panels to an exact dimension and not to be adjusted to the nearest width across the standard pattern of the load bars.

Fingers

IN FRP (Fibre Reinforced Polymer) grating this describes a panel cut that does not run adjacent to the load bar.

Span

Overall dimension of a panel measured parallel with load bar.

This is indicated on drawings by this symbol 

Width

Overall dimension of a panel measured at right angles to the load bars.

Always called “width” even if greater than the length.

Serrations

Small notches made in the top edge of the load bar to assist in slip resistance.

Nosing

A member attached to or on the leading edge of a stair tread or at the top of a flight of stairs to assist slip resistance and to give a clear visual indication of the edge of the stairtreads.

These can be:

- Abrasive yellow nosing (FRP Glow or metal)
- Strip Nosing
- Floor plate

Kick Plate

Heavy section flat bar welded to ends or sides of panels and around cut outs, etc. when specified. Top edge to be 100mm above grating generally and is typically 130 x 6mm.

Cut Out

Grating areas removed from panel to permit passage for installation of pipes, plant and structural or handrail items.

Penetrations

As for cut outs, but typically within the grating panel and not on the edge.

Gross Area

The total area of grating as shown on drawings using overall width and length dimensions of grating ie: $W \times L$.

The gross area is always the area calculated for invoicing purposes.

Aluminium Grating

Our Aluminium Grating is used in both industrial and Architectural Applications.

As well as platform walkways highly corrosive environments, its aesthetic appeal makes it ideal for, Security screens, side barriers, entranceways, parking deck facades.

Industrial Applications

- Sewerage Treatment Plants
- Waste water treatment
- Chemical Process Plants
- Milk Processing plants
- Variety of Marine Applications

Aluminium Grating Load Table (load bars at 30mm pitch)

Type	Cross Rod Pitch (mm)	Mass kg/m ²	Load Bar Size (mm)	Span (mm)												
				450	600	750	900	1050	1200	1500	1800	2100	2400	2700	3000	
PGA705/1/100	100	36.69	70x5	S	533.50	299.20	191.40	133.10	97.80	62.59	32.66	16.59	10.24	6.45	4.24	3.05
PGA705/1/50	50	38.09		D	0.86	1.53	2.39	3.44	4.68	5.13	6.52	7.00	8.00	8.57	9.10	10.00
PGA655/1/100	100	34.17	65x5	S	485.00	272.00	174.00	121.00	88.90	68.00	28.12	15.38	9.30	5.84	3.73	
PGA655/1/50	50	35.57		D	0.97	1.73	2.71	3.90	5.31	6.94	7.00	8.00	9.00	9.70	10.00	
PGA605/1/100	100	31.65	60x5	S	380.00	210.00	130.00	90.00	60.00	53.00	22.11	12.09	7.31	4.59	2.93	
PGA605/1/50	50	33.05		D	0.96	1.70	2.58	3.69	4.56	6.88	7.00	8.00	9.00	9.70	10.00	
PGA555/1/100	100	29.13	55x5	S	331.00	186.00	119.00	82.60	60.60	40.37	16.92	9.28	5.66	3.62		
PGA555/1/50	50	30.53		D	1.09	1.95	3.05	4.39	5.98	6.82	7.00	8.00	9.09	10.00		
PGA505/1/100	100	26.61	50x5	S	281.00	158.00	101.00	70.10	43.80	30.40	12.73	6.95	4.20	2.73		
PGA505/1/50	50	28.01		D	1.24	2.21	3.45	4.97	5.77	6.84	7.00	8.00	9.00	10.00		
PGA455/1/100	100	24.09	45x5	S	237.00	133.00	85.20	59.10	37.85	22.71	10.61	5.71	3.38			
PGA455/1/50	50	25.49		D	1.43	2.55	3.99	5.75	6.83	7.00	8.00	9.00	10.00			
PGA405/1/100	100	21.57	40x5	S	198.00	111.00	71.20	42.17	24.53	16.60	7.07	4.15	2.39			
PGA405/1/50	50	22.97		D	1.71	3.04	4.75	5.84	6.31	7.00	8.00	9.30	10.00			
PGA305/1/100	100	16.53	30x5	S	91.46	51.74	33.04	19.86	11.53	7.77	3.84	1.86				
PGA305/1/50	50	17.93		D	1.88	3.35	5.24	6.55	7.00	8.00	9.80	10.00				
PGA255/1/100	100	14.01	25x5	S	58.70	31.02	18.42	10.53	6.62	4.91	2.25					
PGA255/1/50	50	15.41		D	2.08	3.47	5.05	6.00	7.00	8.90	10.00					

(U=Safe superimposed uniformly distributed load in kN/m²)

(D= Deflection in millimetres)

(Mass in loading table is including banding bars)



Aluminium Grating Load Table (load bars at 40mm pitch)

Type	Cross Rod Pitch (mm)	Mass kg/m ²	Load Bar Size (mm)	Span (mm)												
					450	600	750	900	1050	1200	1500	1800	2100	2400	2700	3000
PGA705/2/100	100	28.85	70x5	S	400.00	224.00	143.55	99.80	73.00	46.90	24.50	12.44	7.68	4.80	3.18	2.28
PGA705/2/50	50	30.25		D	0.86	1.50	2.39	3.43	4.66	5.12	6.54	7.00	8.00	8.57	9.10	10.00
PGA655/2/100	100	26.89	65x5	S	364.00	204.00	130.00	91.00	66.67	51.00	21.10	11.50	6.97	4.38	2.80	
PGA655/2/50	50	28.29		D	0.97	1.73	2.71	3.90	5.31	6.94	7.00	8.00	9.00	9.70	10.00	
PGA605/2/100	100	24.93	60x5	S	285.00	157.50	97.50	67.50	45.00	39.75	16.58	9.06	5.48	3.44	2.20	
PGA605/2/50	50	26.33		D	0.96	1.70	2.58	3.69	4.56	6.88	7.00	8.00	9.00	9.70	10.00	
PGA555/2/100	100	22.97	55x5	S	248.00	139.00	89.00	62.00	45.45	30.00	12.69	6.96	4.24	2.70		
PGA555/2/50	50	24.37		D	1.09	1.95	3.05	4.39	5.98	6.82	7.00	8.00	9.09	10.00		
PGA505/2/100	100	21.01	50x5	S	210.00	118.50	75.75	52.57	32.80	22.80	9.50	5.20	3.15	2.00		
PGA505/2/50	50	22.41		D	1.24	2.21	3.45	4.97	5.77	6.84	7.00	8.00	9.00	10.00		
PGA455/2/100	100	19.05	45x5	S	177.00	100.00	64.00	44.30	28.38	17.00	7.95	4.28	2.50			
PGA455/2/50	50	20.45		D	1.43	2.55	3.99	5.75	6.83	7.00	8.00	9.00	10.00			
PGA405/2/100	100	17.09	40x5	S	148.00	83.00	53.40	31.60	18.40	12.45	5.30	3.10	1.79			
PGA405/2/50	50	18.49		D	1.71	3.04	4.75	5.84	6.31	7.00	8.00	9.30	10.00			
PGA305/2/100	100	13.17	30x5	S	68.60	38.60	24.78	14.90	8.65	5.80	2.88	1.40				
PGA305/2/50	50	14.57		D	1.88	3.35	5.24	6.55	7.00	8.00	9.80	10.00				
PGA255/2/100	100	11.21	25x5	S	44.02	23.26	13.81	7.90	4.96	3.68	1.68					
PGA255/2/50	50	12.61		D	3.47	5.05	6.00	7.00	8.00	9.00	10.00					



Industrial floor grating and handrail stanchions.

The complete package of manufacture, galvanizing and delivery.

Refer to our terms and conditions of trade.

For quotations or general enquiries, contact Perry Grating:

Email grating@perry.co.nz

Freephone 0800 425 848